

Dinel[®]

Data Sheet

Antenna Radar Level Meter Model ARLM-70

Distributed by

BRISTOL
 **INSTRUMENTS**

[www. BristolInstruments.com](http://www.BristolInstruments.com)

Bristol Instruments
90 Canal Street, 4th Floor
Boston, MA 02114

Toll free
877-866-8500

ARLM-70

Dinel®

ANTENNA RADAR LEVEL METER „AMANDA“

Designed for reliable level measurement of various liquids.



HART
COMMUNICATION PROTOCOL



- **Antenna radar level meter, works on the FMCW principle with a frequency of 25 GHz**
- **Display of values on OLED or LCD display**
- **Measuring range up to 20 m**
- **Current output (4 ... 20 mA) with HART® protocol**
- **Measurement independent of the temperature and pressure of the atmosphere above the surface**
- **The possibility of measuring even in aggressive vapours**



PRELIMINARY DATA

Technical specifications

Work environment	explosion-free area	
Supply voltage	18 - 36 V DC	
Output type	current 4 - 20 mA with HART communication (limit values 3.9 - 20.5 mA)	
Current consumption	4 - 20 mA / max. 22 mA	
Measurement error	3 mm (distance 1m to 20m) 10 mm (distance 0,3m to 1m)	
Maximum range	20 m	
Dead Zone	30 cm	
Function principle	FMCW	
Operating temperature range	-30 ... +70 °C	
Measuring frequency	25 GHz (K-Band)	
Measurement sensitivity	3 levels	
Teaching function	Removal of false reflections from the interior of the tank	
Damping	1 to 99 s	
Status signaling (echo dropout)	adjustable 3,75mA, 4mA, 20mA, 22mA, NO CHANGE	
The time of the first measurement from the start of the power supply	20 s	
Separation capacity „power leads - housing“	4nF / 500 V AC	
Maximum load resistance at	U=24V U=22V U=20V	R=270 Ω* R=180 Ω R= 90 Ω
Protection class	IP 67	
Recommended cable	PVC 2x0,75 mm ² with a diameter of 6-8 mm	
Tightening torque of the cable gland	3 Nm	
Weight	cca 0,5 kg	

*Including HART 250Ω resistor

BASIC FEATURES AND USE

Non-contact radar level meters with an antenna are suitable for continuous level measurement at medium and longer distances. They can be used both in various closed tanks, containers, in semi-open sumps, and in open space. Their use is suitable where their advantages are fully applied:

- 1, non-contact measurement
- 2, the independence of the measurement from the temperature and pressure of the atmosphere above the surface
- 3, the possibility of measuring even in a vacuum
- 4, the possibility of measuring even in aggressive vapors
- 5, the measurement is independent of the medium parameters

The ARLM-70 „Amanda“ radar level gauge works on the FMCW (frequency modulated continuous wave) principle with a frequency of 25 GHz (K-Band).

The level meter is equipped with a compact covered funnel antenna. The antenna cover prevents dirt, vapors and gases from entering the antenna.

The ARLM-70 is intended for measuring the level of liquid substances.

The level meter is two-wire with a current output of 4 - 20 mA with HART communication. The measuring range is within 0.3 to 20 m.

DIMENSIONS

ARLM-70

CABLE GLAND DESIGN

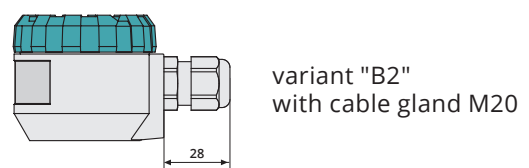
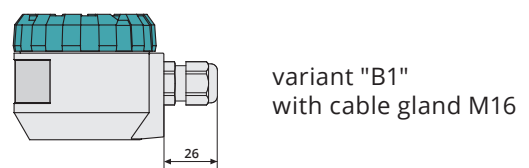
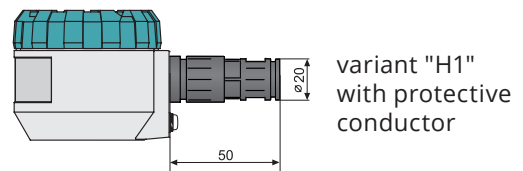
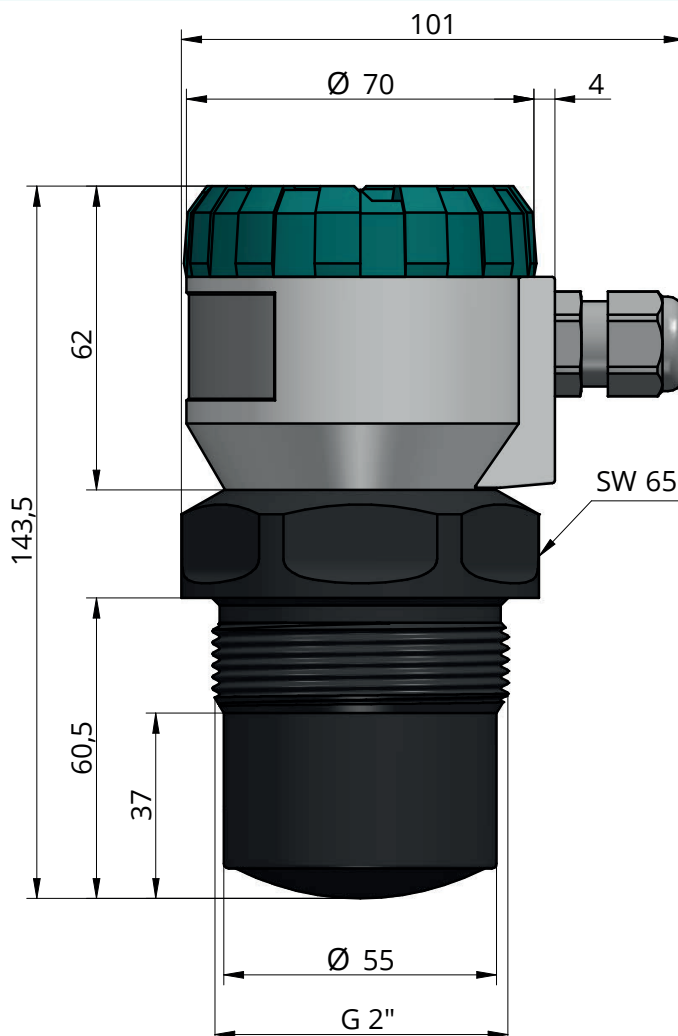

Further information can be found in the ARLM-70 manual on our website www.dinel.cz

TECHNICAL SPECIFICATIONS

TECHNICAL SPECIFICATIONS – DISPLAY MODULE

Type of display		matrix OLED, LCD
Resolution		128 x 64 pixels
Height of digits / Number of display digits of measured values		9 mm / 5 digits
Colour of display	OLED LCD	yellow black with white background light
Type of buttons		low lift membrane
Ambient temperature range	OLED LCD	-30 ... +70 °C -20 ... +70 °C
Weight		46 g

OLED- suitable for indoor and low-light applications.

LCD – suitable for outdoor applications particularly with direct sunlight.

USED MATERIALS

unsubmerged parts of the sensor	Variants	Standard material
Lid	ARLM-70N	aluminium alloy with powder coating
Glass	all types	polycarbonate
Body	ARLM-70N	aluminium alloy with powder coating
Housing (antenna cover)	all types	plastic material PP
Cable gland	ARLM-70N	plastic - polyamide
Internal measuring module	all types	plastic material POM
Display and setting module	all types	plastic material POM
Internal pouring	all types	polyurethane potting compound

INSTALLATION AND OPERATION

The level meters are mounted in a vertical position in a suitable flange in the upper lid of the tank, or into the hole using the fixing nut. The tightening torque needs to be selected taking into account the gasket used and the working overpressure in the tank.

The place for installation must be chosen so that the electromagnetic wave (transmitted by the level gauge) is not affected by nearby objects (reinforcements, ladders, stirrers, etc.) or by the flow of the liquid being filled. The level gauge can be placed in a pipe extension that has a length smaller than the diameter.

If the level meter has not yet been installed, it must be stored in an intact condition with the cap tightened and the sealing plug in the cable gland.

The level meter does not require any operator to operate. During operation, the operator of the technological unit is informed about the height of the measured substance level using a display module or a follow-up device.

ELECTRICAL CONNECTION

When using the M16 socket, the level meter is connected to the follow-up (evaluation) device with a suitable cable with an external diameter of 6 - 8 mm via screw terminals located under the display module. Recommend. the core cross-section for the current version is 2 x 0.5 - 0.75 mm². The positive pole (+U) is connected to the (+) terminal, the negative pole (0 V) to the (-) terminal and the shield (only for shielded cables) is connected to the (⏏).

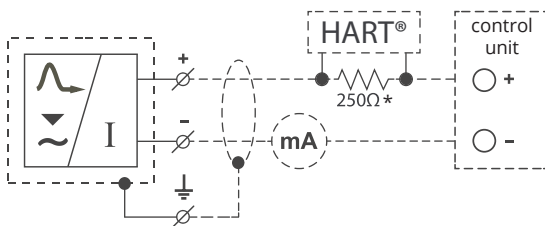

* In the possible use of Hart® communication
Wiring diagram of the level meter with current output ARLM-70

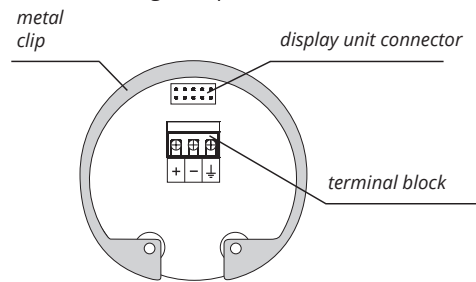

Inside view of screw terminals of the level meter with current output ARLM-70

SETTING ELEMENTS

Settings are performed using 3 buttons located on the display module DM-70. All the settings are available in the menu of the level meter.

Button

- Set-up mode access
- Confirmation of selected item in the menu
- Move the cursor in the line
- Saving of set-up data

Button

- Move in the menu
- Change of values

Button

- Cancelling of carried out changes
- Shift one level up

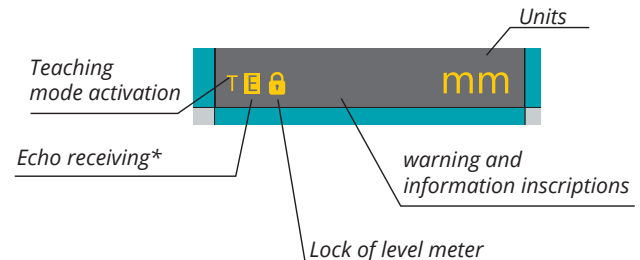
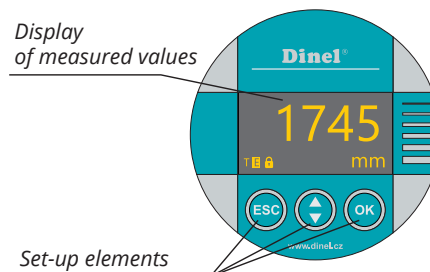

* Slow flashing while the reflected signal (echo) is received from the measured level.

ORDER CODE

ARLM-70

FINISH

N basic design for non-explosive environments, aluminum body

MAXIMAL RANGE

20 0,3 ... 20m

PROCESS CONNECTION

G2 pipe thread G2"

OUTPUT TYPE

I 4-20mA current loop with HART communication

ELECTRICAL CONNECTION

B1 plastic cable gland M16

B2 plastic cable gland M20

H1 plastic cable gland for protective hose

SET-UP ELEMENTS

D version with OLED display (transparent lid)





C version with LCD display (transparent lid)

L without display (full lid without glass)

ARLM-70 N - 20 - G2 - I - B2 - D

EXAMPLE OF CODING

ACCESSORIES

1x O-ring EPDM	included in the price		
universal convertor from USB to HART	at extra cost	UHC-01	
display unit	at extra cost	DM-70	
fixing nut plastic G2"	at extra cost	PUM-G2	
extension cable for display	at extra cost	PK-70-1	

The manufacturer reserves the right to change the specifications and appearance of the product without prior notice.

Dinel, s. r. o.
U Tescomy 249, 760 01 Zlín, Czech Republic

version:
11/2023