



Data Sheet
TG-30 Series
Gas Thermometer -
Stainless Steel

Distributed by



www.bristolinstruments.com

Bristol Instruments
90 Canal Street
4th Floor
Boston, MA 02114

Toll free 877-866-8500

Gas thermometers Stainless steel version

**Dial size: ND of 4 and 6 in.
(100 and 160 mm)
Accuracy: ±1% of full scale**

Features

Fulfills highest measurement technology requirements, Gas pressure with inert gas filling is physiological harmless
Short response time
For aggressive media

Applications

Chemical and petrochemical industry
Energy economy , Process engineering
Container and pipe construction
Mechanical engineering and apparatus manufacture,
Special customised versions available,
Food industry



Model and ND	TG-30 100	TG-35 100	TG-30 160	TG-35 160
Connection	bottom	back, eccentric	bottom	back, eccentric
Ranges in °C	-100...+100°C, -50...+50°C, -40...+40°C, -40...+60°C, -30...+50, -20...+60°C, -20...+80°C 0...80°C, 0...100°C, 0...120°C, 0...160°C, 0...200°C, 0...250°C, 0...300°C 0...400°C, 0...500°C, 0...+600°C			
Ranges in °F	0 ...150 °F, 0...200 °F, 0...250 °F, 0...300 °F -50...+130 °F, -40...+160, -30...+120 °F, 20...240°F, 40...400 °F 50...300 °F, 50...500 °F, 100...800 °F, 100...1000 °F, 150...700°F, other at inquiry			
Application	Full scale value			
Case	CrNi steel			
Bezel	CrNi steel ,bayonet			
Window	Glass lens			
Dial	Aluminum white, scale black			
Pointer	Aluminum, black			
Measuring element	Gas pressure system with inert gas filling			
Display correction	at case, max. 6 %			
Shaft	CrNi steel			
Connection	See data sheet T 290			
Length	63, 100, 150, 200, 250, 300, 350, 400, 450, 500 mm, other length possible *)			
Max. pressure	25 bar at shaft, without thermowell			
Protection	IP 55 according EN 60529 / IEC 529			
Weight	0.6 kg	0.6 kg	1.1 kg	1.1 kg

Dimensions

Connection bottom

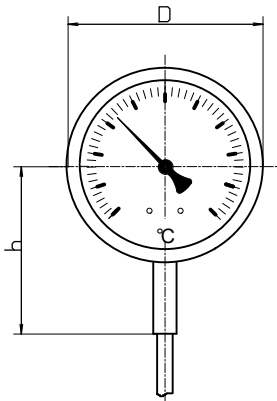

Connection ,back eccentric

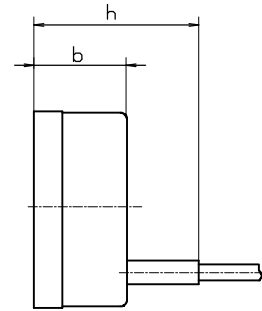
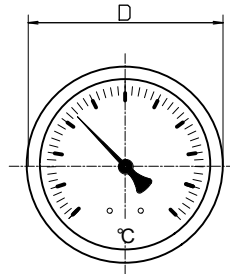
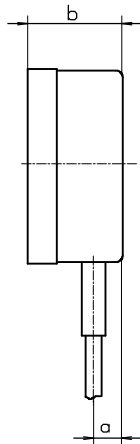

Hole diagram for front flange

rear flange

front flange

with triangular bezel and mounting bracket

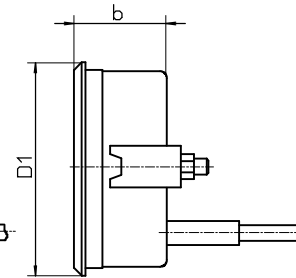
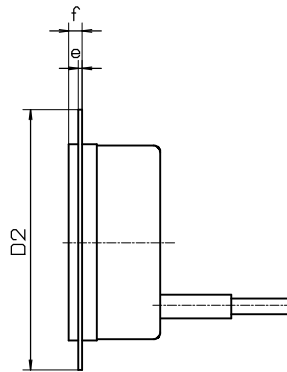
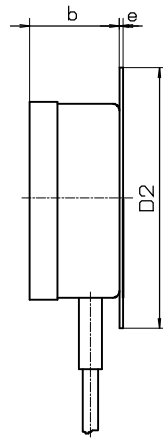
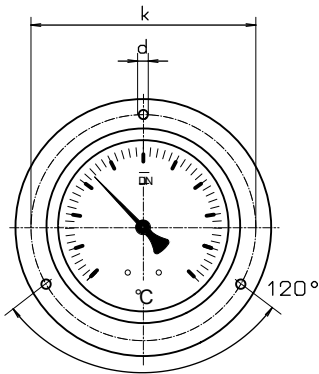

Dimensions in mm											
Model	NG	D	a	b	h	D1	D2	e	f	k	d
TG-30	100	101	16	43	99	107	132	2	6	116	4,8
TG-35	100	101	16	43	99	107	132	2	6	116	4,8
TG-30	160	160	16	51	111	-	196	2	6	178	5,8
TG-35	160	160	16	51	111	-	196	2	6	178	5,8

Model specification

Model

TG-3

Connection

0 or 5

Connection bottom = 0

Connection back = 5

Nominal size

f.e. 100

Case with ND 100 = 100
Case with ND 160 = 160

Range

f.e. 120

after Range
specification or direct
f.e. 120 °C

Stem length

f.e. 100

Stem length in mm

Stem type

f.e. F 2

lock at data
sheet T 290